

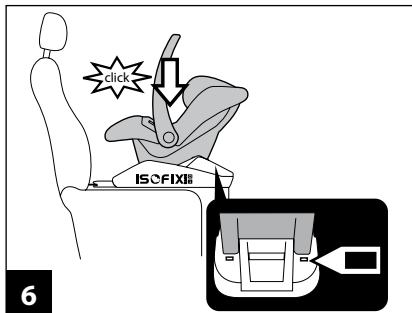

# **isofix base 0<sup>+</sup>1 K**

Instructions for use  
PVIB\_0236\_0313\_V1

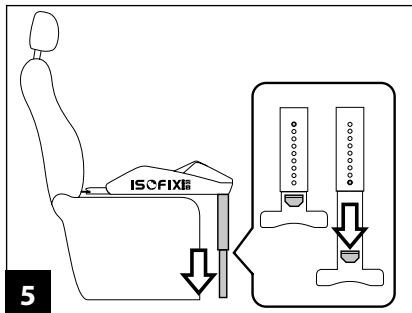

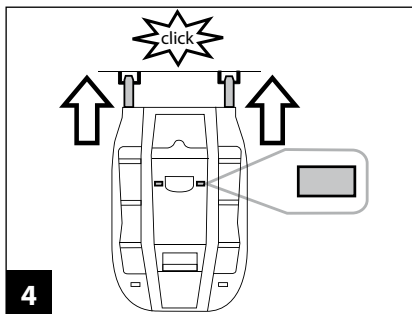
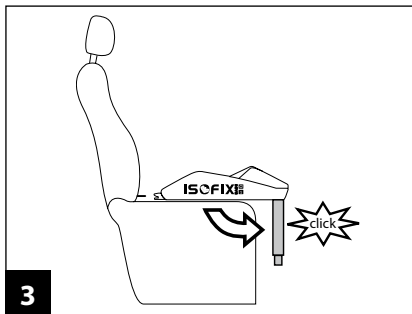
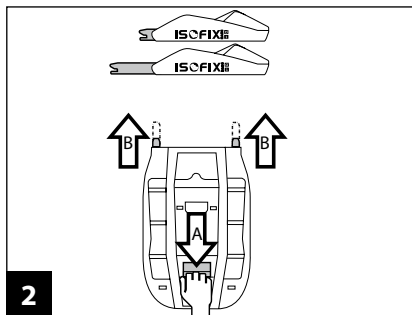
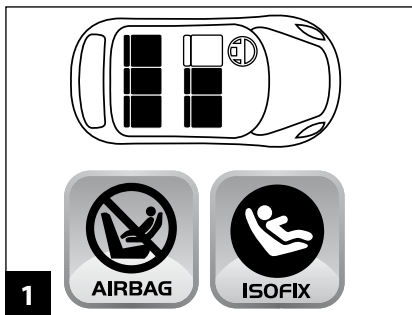
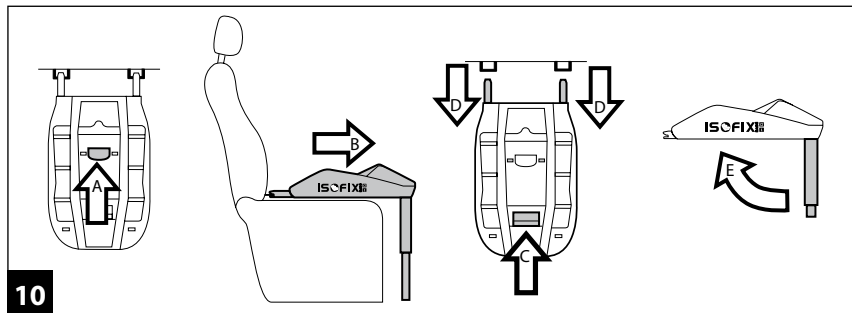
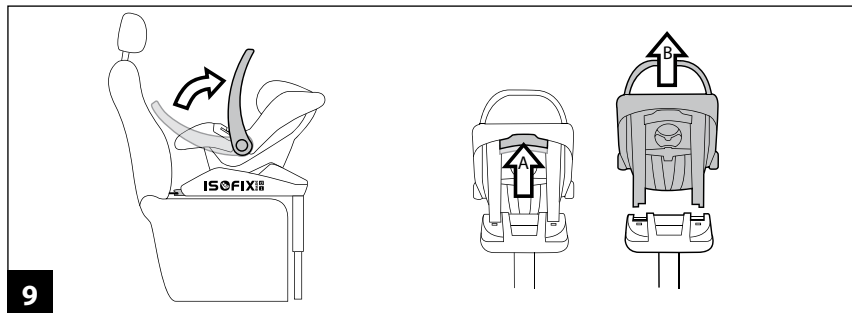
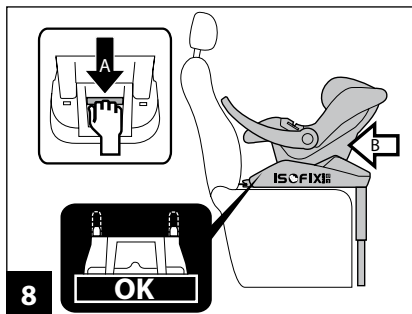
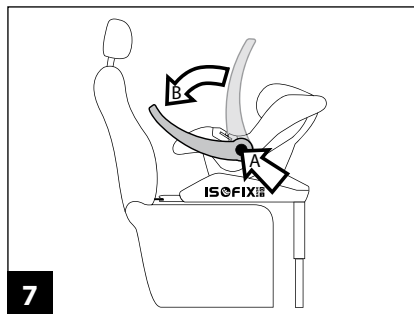

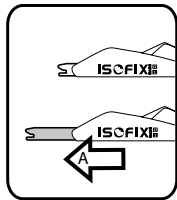

11

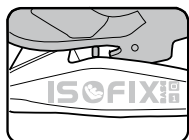
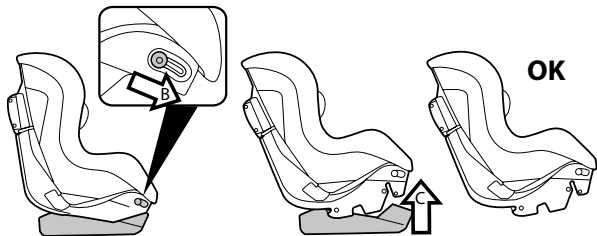

12

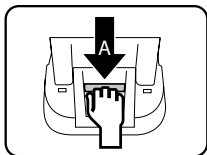
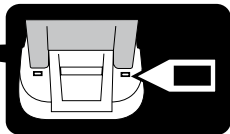
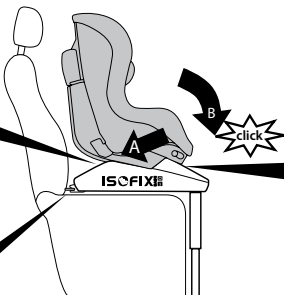
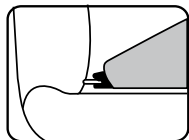

13

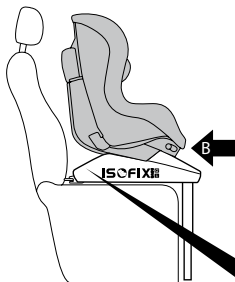

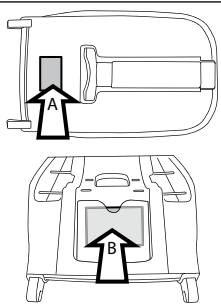

## EN\_English

### Thank you for choosing a Mamas & Papas product.

#### Product compatibility

- "Isofix Base 0+1 K" may be used exclusively with any models of the car seats "Primo Viaggio IP", "Primo Viaggio SL" and "VITO".
- Do not use the Isofix Base 0+1 K with the car seats "Primo Viaggio" or "Primo Viaggio SIP".

#### Product characteristics

- "Isofix Base 0+1 K" must be fitted on vehicle seats facing in the normal direction of travel. Do not fit "Isofix Base 0+1 K" on seats with airbags or on seats that face away or sideways with respect to the normal direction of travel of the vehicle.
- The use of "Isofix Base 0+1 K" ensures greater safety and ease of mounting for Peg Perego child car seats.
- Ensure that the vehicle is fitted with an Isofix system. Check the list of car models provided with the product.

#### ⚠ WARNING

- Read the instructions carefully before use and keep them in the holder provided for future reference. Failure to closely follow the installation instructions for the car safety seat will put your child at risk.
- The assembly and installation operations must be conducted by adults.
- Avoid inserting fingers into the mechanisms.
- Death or serious injury can result if this safety seat base is installed on seats with airbags.
- Eliminate danger by disabling airbags surrounding the position of the car safety seat.
- When travelling take special care to make sure that luggage or other objects do not injure the child in the safety seat in the case of accidents.
- Do not use installation methods different from those indicated. This would result in the risk of detachment from the seat.
- Child car seat base, group 0+, "Semi-Universal" category, class E for use with any models of the car seats "Primo Viaggio IP", "Primo Viaggio SL". Approved under European standard ECE R44/04 for children weighing from 0 to 13 kg (0 to 12/14 months). Only for use in vehicles fitted with Isofix approved points (for details see the list of car models fitted with Isofix attachment systems).
- Child car seat base, group 1, "Semi-Universal" category, class A for use with VITO and all its models. Approved under European standard ECE R44/04 for children weighing from 9 to 18 kg (from 9 months to 4 years approx). It can only be used in vehicles with approved Isofix points.
- Check the vehicle's use and maintenance manual to see whether it is compatible with Isofix child restraint systems.
- If you are unsure of anything, contact the manufacturer or the retailer of this child car seat.

- Do not remove the stickers; this could mean that the product no longer conforms with standards.
- Do not use this base if it is broken or has missing parts, if it is second-hand or of uncertain origin, or if it has undergone violent strain in an accident, as it may have suffered extremely dangerous structural damage.
- Do not modify the product.
- For any repairs, replacement parts or information on the product, contact the post-sales assistance service. The relevant information is provided on the last page of this manual.
- Do not use this base after a period of five years has passed from the date of production indicated on the bottom. The natural ageing of the materials may mean that it is no longer compliant with standards.

## Instructions for use in car

1. Find the Isofix attachment points on the car seats.
2. Lengthen the Isofix attachments on the base by pressing the lever as shown in the figure, to facilitate fastening.
3. Extract the support leg from under the base and fold it outwards until it clicks into position. Position the base on the car seat as shown in the figure, aligned with the Isofix attachments.
4. Engage the attachments on the base to the seat buckles (check that there is nothing interfering with the seat buckles that could stop them from functioning properly).
  - **▲ IMPORTANT:** The two signals on the sides of the handle go from red to green to indicate that it is properly attached.
  - **▲ IMPORTANT:** Once the procedure is complete, move the base to check that both Isofix points are actually attached.
5. Adjust the height of the support leg by pressing down the inner catch until it touches the car floor (it is important for the leg to be well supported on the car floor even if this causes the base to be slightly raised from the vehicle seat).

- Once the above steps are complete, "Isofix Base 0+1 K" can remain in the car ready for use.
- If your car has storage compartments on the floor of the vehicle, in the area where the support leg is to rest, you should open the compartment and rest the leg on the bottom of it.

## Connecting Primo Viaggio IP / Primo Viaggio SL

6. Place the child in the car seat safety seat, remembering to secure him/her with the harness. Lift the chair with the handle (facing the opposite direction to normal vehicle movement) and engage to the base by pressing down with both hands on the chair until it clicks into place.
  - **▲ IMPORTANT:** The two signals behind the base go from red to green to indicate that the child car seat is properly attached.
  - **▲ IMPORTANT:** Once the procedure is complete, move the child car seat to check that it is actually attached.
7. Inside the car, the handle must be fully lowered towards the backrest of the vehicle seat, as shown in the figure. Press the round buttons on the handle and at the same time rotate the handle as shown in the figure until it clicks into position.
8. Pull the handle on the base and push the base with the child car seat against the vehicle seat until they can go no further.
  - **▲ IMPORTANT:** It is possible to check that the base is correctly positioned by looking at the signals on the handle. OK (green) indicates that the position is correct, NO (red) indicates that the procedure has been carried out incorrectly and must be repeated until the handle only shows the term "OK".
9. To release the child car seat from the base: raise the handle to its transport position, push the lever on the backrest upwards and at the same time lift the seat.
10. To release the base from the vehicle seat: release the Isofix connectors from the fixing points in the car by lifting the handle on the base (Arrow A) and pulling the base in the

normal direction of travel (Arrow B). Pull the handle (Arrow C) and push the connectors back inside the base (Arrow D). Rotate the support leg and place it in its housing (Arrow E).

## Connecting VITO and all its models

**▲ IMPORTANT: the car seat must be attached without the child in it.**

- Before connecting the car seat on the Isofix base, ensure that the child car seat's Isofix connectors are fully extended (Arrow A).
  - If you have any difficulty fitting car seat in your car, lift up or remove the vehicle's headrests.
- 11\* Remove the plastic casing attached to the child car seat with the special release switches (Arrows B and C).
- 12\* Position the child car seat on the Isofix Base 0+1 K and insert the rear connectors of the child car seat in the fixing points of the base nearest to the vehicle seat (Arrow A).
- Press the front part of the child car seat until it clicks into place (Arrow B).
- ▲ IMPORTANT:** The two signals behind the base go from red to green to indicate that the child car seat is properly attached to the base.
- 13\* Pull the handle on the base (indicated by Arrow A) and push the base with the child car seat against the vehicle seat until they can go no further (indicated by Arrow B).
- ▲ IMPORTANT:** It is possible to check that the base is correctly positioned by looking at the signals on the handle. OK (green) indicates that the position is correct, NO (red) indicates that the procedure has been carried out incorrectly and must be repeated until the handle only shows the term "OK".
- ▲ IMPORTANT:** Once the procedure is complete, move the base to check that both Isofix points are actually attached.

## Serial numbers

- 14\* On the underside of the Isofix Base 0+1 K, near the isofix connectors, the following information is provided: product name, date of manufacture and serial number of the product itself (Fig. a).
- The approval label is located on the Isofix Base 0+1 K behind the compartment holding the instruction sheet (Fig. b). This information is required for any complaints.

## Cleaning and maintenance

- This product requires a small amount of maintenance. Cleaning and maintenance must only be carried out by adults.
- Clean the plastic parts periodically with a damp cloth. Do not use solvents or other similar products.
- Protect the product from atmospheric agents: humidity, rain or snow. Extended exposure to sunshine can cause colour changes in many materials.
- Store the product in a dry environment.

## How to read the approval label

This paragraph explains how to read the approval label (the orange label located in the instruction sheet compartment).

- The terms SEMI-UNIVERSAL class E and class A indicate the compatibility of the child car seat with vehicles fitted with Isofix attachment systems.
- The top of the label displays the trademark of the manufacturing company and the name of the product.
- The letter E in a circle indicates the European approval mark and the number indicates the country that issued the approval (1: Germany, 2: France, 3: Italy, 4: The Netherlands, 11: Great Britain, and 24: Ireland).
- Approval number: if it starts with 04 this indicates the fourth amendment (the one currently in force) of Regulation R44.
- Reference standard: ECE R44/04.
- Production serial number: on issue of approval each safety seat is personalized with its own number.

# mamas & papas®

---

HD5 0RH, UK

---



mamasandpapas.com  
mamasandpapas.ca  
mamaspapas.kr

---



**UK** T: +44 (0)845 268 2000  
**USA** T: 1-800-490-0331  
**CAN** T: 1-800-667-4111  
**AU** T: 1300-663-034

---



/mamasandpapasuk  
/mamasandpapasusa  
/mamasandpapasmltregion  
/mamasandpapasmagyarorszag

---



@mamasandpapas

---



/user/mamasandpapasglobal

---



mamasandpapasblog.com

---



/mamasandpapas

---

